



TIROL KIT
21-0120-023



XTREME TIROL KIT
21-00056



XTREME CONTROL TIROL KIT
21-00055

Tirol Kit Series

Rel.28102024English



*Read this manual
carefully and keep it
for future reference*

TABLE OF CONTENTS

1. SAFETY INFORMATION	5
1.1 General safety information	5
1.2 Glossary of symbols	6
1.3 Blood-borne diseases	7
1.4 Load capacity	7
1.5 Compatible Basket stretchers	7
2. OPERATOR TRAINING AND SKILLS	8
2.1 Skills	8
2.2 Training	8
3. TIROL KIT	9
3.1 Description	9
3.2 General technical specifications	13
3.3 CE Compliance	13
3.4 Reporting accidents	13
4. ASSEMBLY	14
4.1 Toothed shaft assembly	15
4.1.1 Toothed shaft assembly on Titan-Ti stretcher with welded plates	15
4.1.1.1 Installing toothed shafts in internal configuration	16
4.1.1.2. Installing toothed shafts in external configuration	17
4.1.2. Toothed shaft assembly on stretchers with adapter kit	18
4.2 Handle assembly	20
4.2.1 Adjusting the angle of the handles	21
4.3 V-Shaped support assembly	23
4.4 Wheel assembly	24
4.4.1 Wheel assembly for Tirol Kit and Xtreme Tirol Kit	24
4.4.2 Wheel assembly for Xtreme Control Tirol	26
4.5 Shoulder support application	32
5. MAINTENANCE	33
5.1 Periodic maintenance and preventive checks	33
5.2 Disinfection/Decontamination	34
5.3 Disinfection/Cleaning of Shoulders Supports	34
5.4 Cleaning the Wheel	34
5.4.1 Cleaning the Xtreme Control wheel	34
5.5 Inspection	35
5.6 Lubrication	35
5.7 Brake pad adjustment on Xtreme Control wheel	36
6. ACCESSORIES	37
6.1 Adapter Kit	39
6.1.1 Compatible stretchers	39
6.1.2 Installing the Adapter Kit for tapered stretchers	39
6.1.3 Installing the Adapter Kit for regular stretchers	46
7. TECHNICAL SUPPORT	47
8. WARRANTY	48
8.1 Warranty terms and conditions	48
8.2 Limitation of liability	49
8.3 Warranty claims	49
8.4 Complaints	49
8.5 Return authorisations	49

Technical Support Ferno S.r.l.

Customer Service and Technical Support are important aspects of every Ferno S.r.l. product

Before contacting us, note the serial number of the product and specify it in all written communications.

For all queries concerning technical support, contact Ferno S.r.l.:

- Telephone: 800 501 711 (toll-free for Italy)
- Telephone: (+39) 0516860028
- E-mail: info.it@ferno.com

Ferno S.r.l. Customer Service

For assistance and further information, contact Ferno S.r.l. Customer Service:

MANUFACTURER

Ferno S.r.l., Via Benedetto Zallone 26 - 40066 - Pieve di Cento (BO) - ITALY

- Telephone: 800 501 711 (toll-free for Italy)
- Telephone: (+39) 0516860028
- Fax: (+39) 0516861508
- Website: www.ferno.it



USER AND MAINTENANCE MANUAL

To request additional free copies of the instruction manual, please contact Ferno S.r.l. Customer Service

Limitation of liability

This manual contains general instructions on the use and maintenance of the product. The instructions do not cover all possible applications and operations. The user is solely responsible for proper and safe use of the product. The safety information is provided as a service to the user and ensures only the minimum required level of safety to prevent injury to operators and patients. Any other safety measure implemented by the user must comply with applicable regulations. Before using the product, it is strongly recommended that staff be trained in its correct usage. Retain this manual for future reference. In case of change of ownership, ensure that the manual remains with the product. Additional free copies can be obtained from Ferno S.r.l. Customer Service

Intellectual property declaration

The information contained in this manual is the property of Ferno S.r.l. - Via Benedetto Zallone 26, 40066 Pieve di Cento (BO). All patent rights, design, construction, reproduction, use and sale rights relating to any item covered in this manual are the confidential and exclusive property of Ferno S.r.l., except for rights expressly transferred to third parties or not attributable to parties owned by the supplier. It is prohibited to reproduce this manual, either in full or in part, without the prior consent of Ferno S.r.l.

Limited warranty

Ferno S.r.l. Products are covered by a 24-month warranty against manufacturing defects. For the full terms and conditions of warranty and liability, see chapter Warranty.

1. SAFETY INFORMATION

1.1 General safety information

The main safety-related instructions are given below:

 WARNING
<p>Untrained users may injure themselves, cause damage and/or physical harm. Allow only trained and qualified staff to use the device.</p> <hr/> <p>Improper use of the device may cause damage and/or injury. Use the device as described in this manual.</p> <hr/> <p>Occasional assistants may cause damage and/or physical harm, or injure themselves. Always keep the device under control, activate the controls, and coordinate the assistants.</p> <hr/> <p>An unassisted patient is at risk of injury. Never leave the patient alone, and always assist the patient when using the device.</p> <hr/> <p>Incorrect fastening of the restraints may result in the patient being displaced with consequent danger of injury and/or damage. The restraints must wrap the device frame.</p> <hr/> <p>Failure to use the restraints can cause the patient to fall and endanger their safety. Always use restraints to secure the patient.</p>

 WARNING
<p>Improper maintenance may cause serious accidents, injuries and/or damage. Perform maintenance as instructed in this user manual.</p> <hr/> <p>The use of improper and/or unauthorised devices may cause accidents, damage, and/or injury. Use only devices that have been approved and authorised by Ferno S.r.l.</p> <hr/> <p>Unauthorised repairs carried out by technicians not approved by Ferno S.r.l. will render all warranties null and void and may compromise the safety of the device.</p> <hr/> <p>The device has been developed and tested for use with all the components indicated in this manual.</p> <hr/> <p>Do not use the Tiroi Kit without handles or other components that are essential for the correct use of the device.</p> <hr/> <p>Using the Tiroi Kit without the handles can cause serious accidents, injury or harm to the patient.</p> <hr/> <p>Non-original spare parts and inadequate repairs may cause damage and/or injury. Use only original Ferno S.r.l. spare parts and refer exclusively to Ferno s.r.l.'s Customer Support.</p>

1.1.1 Important

The boxes marked “Important” contain important information on the use and/or maintenance of the device.



1.2 Glossary of symbols

The symbols used in this manual and/or on labels are defined below.

The CE mark is present on the stretcher, on the accessories and in this manual.



IMPORTANT

The boxes marked “Important” contain important information on the use and/or maintenance of the device.



WARNING

The boxes marked “WARNING” draw attention to potentially dangerous situations that, if disregarded, may result in accidents, damage and/or injury.



Read the user manual carefully



Two qualified operators are recommended for correct use



Medical Device



Manufacturer



Date and country of manufacture



Do not wash with high pressure water



Load capacity
(in kilos, pounds and stones)



This product meets European Union Standards



Part number (abbreviated with PN, P/N, part no., or part #) unambiguously identifies a specific part of the design.



A catalogue number indicates the manufacturer's catalogue number in order to identify the medical device.



A serial number indicates the manufacturer's serial number in order to identify a specific medical device.



A lot code indicates the manufacturer's lot code in order to identify the lot.

1.3 Blood-borne diseases

To reduce the risk of exposure to infectious diseases that may be transmitted by blood, such as HIV-1 or Hepatitis, follow the instructions on disinfection and cleaning in this manual carefully.

1.4 Load capacity

The load capacity of the Tirol Kit is shown below:



1.5 Compatible Basket stretchers

The manual describes the basket stretchers intended for use with all three versions of Tirol Kit.

Below is a list of compatible stretchers:

BASKET STRETCHERS	
Part no.	Description
11-0100A	Tapered Titan SS
11-0101A	Regular Titan SS
11-0115SL	Divisible Regular Titan-Ti
11-0116SL	Titanium Regular Titan-Ti
11-0118SL	Titanium Tapered Titan-Ti
11-0119SL	Divisible Tapered Titan-Ti
11-0119TIROL	Divisible Tapered Titan-Ti with welded plates



WARNING

The described accessories have been tested and validated for use with the listed basket stretchers. Ferno S.r.l. accepts no liability if accessories other than those listed are used.

For more information, please refer to the user manual of the relevant product or contact your local distributor.

2. OPERATOR TRAINING AND SKILLS

2.1 Skills

Operators who use the stretcher must:

- Have specific experience in patient handling procedures.
- Possess the appropriate skills to assist the patient
- Be familiar with search and rescue (SAR) assistance procedures.

2.2 Training

Operators are required to:

- Carefully read and understand all information in this manual.
- Attend a suitable training course on the use of the device.
- Practice with the device before using it in real situations with patients.
- Log the training sessions. An example of a form for logging the training sessions can be found at the end of this manual.
- Follow a training programme prepared by the personnel training officer in charge.

The Tirol Kit must be used by trained and qualified personnel and for professional use only by a minimum of two qualified operators.

Several operators may be needed depending on local protocols.

Additional assistance may be needed to handle heavy patients and/or when the situation requires it and should always be provided according to local health care protocols.



Read the user manual carefully



Two qualified operators are recommended for correct use



WARNING

Make sure that all operators are trained and physically capable of handling loads.

3. TIROL KIT

3.1 Description

The Tirol Kit rescue system is an accessory for Ferno's Titan basket stretchers, developed to facilitate rescue operations in difficult environments, making transportation safer.

The Tirol Kit is designed for ease of use: it is lightweight and divisible.

The Tirol Kit is available in different configurations, depending on the type of wheel applied to the basket stretcher.

The following three versions are available:

- 21-0120-023 Tirol Kit for Titan
- 21-00056 Xtreme Tirol Kit with XXL wheel
- 21-00055 Xtreme Control Tirol Kit with XXL wheel, brake and safety light



WARNING

The device has been developed and tested for use with all the components indicated in this manual.

Do not use the Tirol Kit without handles or other components that are essential for the correct use of the device.

Using the Tirol Kit without the handles can cause serious accidents, injury or harm to the patient.





WARNING

It is very important to always check the correct installation of the various components before using the stretcher for practice and in real-life situations.

The components available for each variant are listed below:

A. TIROL KIT
PART NO. 21-0120-023

Images	Part no.	Description
x 1 	25-1603-001	"Slim" wheel
x 2 	10-3001-4NP	Toothed shaft
x 16 	RPIM8X16A2	M8x16 flat washer
x 8 	VTBTXM8X16A2	M8 screw with 16 mm Torx countersunk head
x 8 	VTBTXM8X20A2	M8 screw with 20 mm Torx countersunk head
x 2 	21-0120-012	Shoulder supports
x 2 	25-00090	Right-hand carrying handle (operator)
x 2 	25-00089	Left-hand carrying handle (operator)
x 1 	25-1607-001-01 (yellow and red)	Yellow and red V-Shaped wheel support
x 1 	25-1608-001_01 (green and blue)	Green and blue V-Shaped wheel support
x 1 	25-1602-001	Wheel locking pin
x 1 	TIROL KIT BAG	Tirol Kit Bag
x 1 	10-00382	Threadlocker
x 1 	10-00378	Presta /Schrader adapter for inflation valve with ring

B. XTREME TIROL KIT WITH XXL WHEEL

PART NO. 21-00056

Images	Part no.	Description
 	25-00158	Xtreme wheel
 	10-3001-4NP	Toothed shaft
 	RPIM8X16A2	M8x16 flat washer
 	VTBTXM8X16A2	M8 screw with 16 mm Torx countersunk head
 	VTBTXM8X20A2	M8 screw with 20 mm Torx countersunk head
 	21-0120-012	Shoulder supports
 	25-00090	Right-hand carrying handle (operator)
 	25-00089	Left-hand carrying handle (operator)
 	25-1607-001-01 (yellow and red)	Yellow and red V-Shaped wheel support
 	25-1608-001_01 (green and blue)	Green and blue V-Shaped wheel support
 	25-1602-001	Wheel locking pin
 	TIROL KIT BAG	Tirol Kit Bag
 	10-00382	Threadlocker
 	10-00378	Presta /Schrader adapter for inflation valve with ring

C. XTREME CONTROL TIROL KIT WITH XXL WHEEL, BRAKE AND LIGHT
PART NO. 21-00055

	Images	Part no.	Description
x 1		25-00132	Xtreme Control XXL wheel with brake and safety light
x 2		10-3001-4NP	Toothed shaft
x 16		RPIM8X16A2	M8x16 flat washer
x 8		VTBTXM8X16A2	M8 screw with 16 mm Torx countersunk head
x 8		VTBTXM8X20A2	M8 screw with 20 mm Torx countersunk head
x 2		21-0120-012	Shoulder supports
x 2		25-00090	Right-hand carrying handle (operator)
x 2		25-00089	Left-hand carrying handle (operator)
x 1		25-1607-001-01 (yellow and red)	Yellow and red V-Shaped wheel support
x 1		25-1608-001_01 (green and blue)	Green and blue V-Shaped wheel support
x 1		25-1602-001	Wheel locking pin
x 1		TIROL KIT BAG	Tirol Kit Bag
x 1		25-000156	Xtreme Control wheel bag
x 1		10-00382	Threadlocker
x 1		10-00378	Presta /Schrader adapter for inflation valve with ring

3.2 General specifications

Ferno S.r.l. reserves the right to change the specifications without notice.

For assistance and further information, contact Ferno S.r.l. Customer Service

Part no.	Description	Weight (kg)	Load capacity
21-0120-023	Tirol Kit for Titan	10.8	
21-00056	Xtreme Tirol Kit with XXL wheel	10.8	
21-00055	Xtreme Control Tirol Kit with XXL wheel, brake and safety light	12	

* For dimensions and further details on the stretcher, please refer to the stretcher-specific manual.

3.3 CE Compliance

Ferno S.r.l. products meet the general safety and performance requirements of Regulation (EU) 2017/745 (MDR) concerning medical devices.

For any further information, please visit: www.ferno.it



3.4 Reporting accidents

In the event of a serious accident in relation to the device, immediately contact Ferno S.r.l. and the competent authority of the member State in which the user has its main office.

- E-mail: eu-regulatory.it@ferno.com
- Phone: +39 051 6860028
- Fax: +39 0518681508

4. ASSEMBLY

The assembly procedures for the Tirol Kit are described below.

Before assembly, check that the stretcher on which the kit will be mounted has welded plates or an Adapter Kit already fitted. For mounting the Adapter Kit on stretchers without plates, please refer to chapter “7.1 Adapter Kit”.

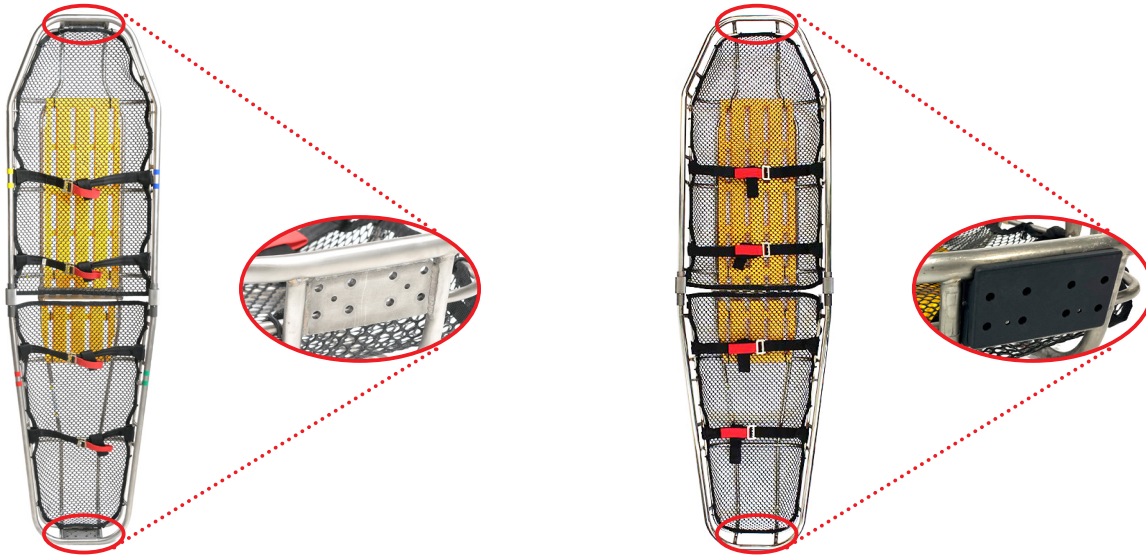

STRETCHER WITH WELDED PLATES

STRETCHER ON WHICH TO MOUNT THE ADAPTER KIT

IMPORTANT

Before starting assembly operations, check that:

- All components of the basket stretcher are present.
- The welds show no signs of cracks, fractures or other signs of breakage.
- The tubular frame of the stretcher is not cracked or bent.
- The Durathene mesh on the stretcher is not torn or broken and is firmly attached to the frame.
- The yellow backrest is firmly fixed to the frame.
- The safety warning labels are clearly visible and legible.
- The fabric restraints are in good conditions, without cuts or signs of excessive wear.
- The restraint buckles do not show visible damage and work correctly.



WARNING

Improper use of the device may cause damage and/or injury.





Use the device as indicated in this manual.

4.1 Toothed shaft assembly

4.1.1 Toothed shaft assembly on Titan-Ti stretcher with welded plates

 WARNING
<p>For mounting the Adapter Kit on stretchers without plates, please refer to chapter "7.1 Adapter Kit".</p>

REQUIRED MATERIAL

Images	Part no.	Description
<p>x 2</p> 	10-3001-4NP	Toothed shaft for the adjustment of handles
<p>x 8</p> 	VTBTXM8X16A2	M8 screw with 16 mm Torx countersunk head
<p>x 8</p> 	VTBTXM8X20A2	M8 screw with 20 mm Torx countersunk head
<p>x 16</p> 	RPIM8X16A2	M8x16 flat washer
<p>x 2</p> 	10-00382	Threadlocker

4.1.1.1 Installing toothed shafts in internal configuration

Instructions

To perform the correct procedure, proceed as described below:

1. Place one RPIM8X16A2 washer on each screw
2. Apply a drop of threadlocker to the threaded edge of the four VTBTXM8X16A2 screws
3. Insert the four VTBTXM8X16A2 screws into the highest through-holes of the welded plate from the outer side of the plate
4. Apply a drop of threadlocker to the threaded edge of the four VTBTXM8X20A2 screws
5. Insert the four VTBTXM8X20A2 screws into the lowest through-holes of the welded plate from the outer side of the plate
6. Position the toothed shaft against the inner side of the welded plate so that the yellow lines are at the top and the red lines at the bottom.
7. Screw securely in place with a Torx T40 wrench.

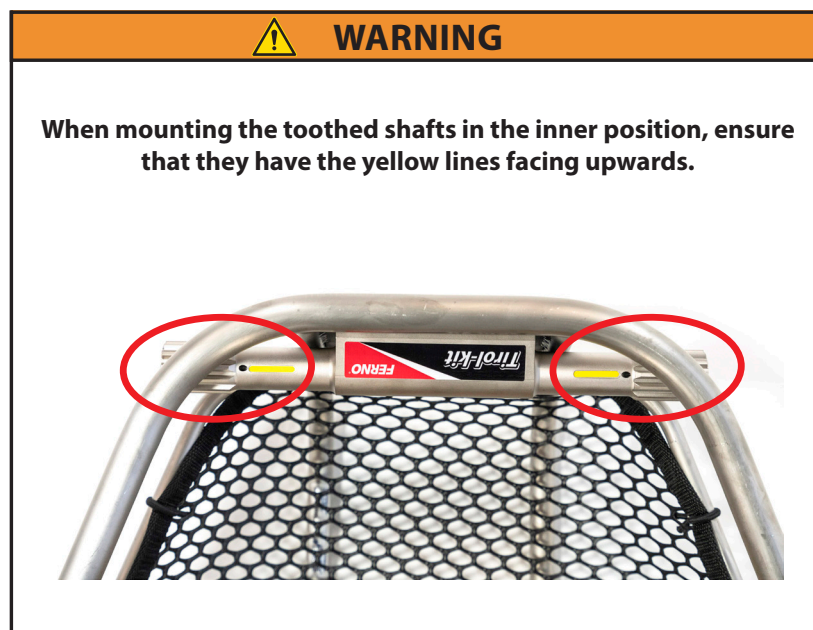
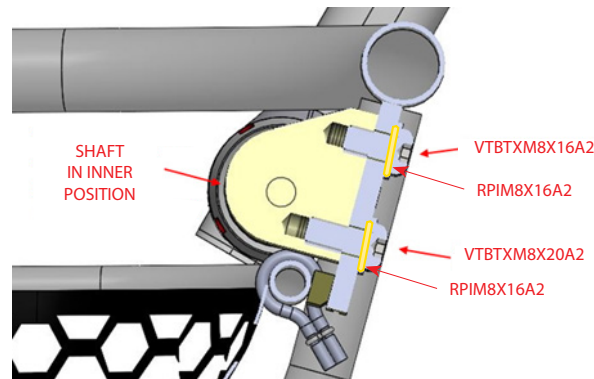

4.1.1.2. Installing toothed shafts in external configuration

Instructions

To perform the correct procedure, proceed as described below:

1. Place one RPIM8X16A2 washer on each screw
2. Apply a drop of threadlocker to the threaded edge of the four VTBTXM8X16A2 screws
3. Insert the four VTBTXM8X16A2 screws into the highest through-holes of the welded plate from the outer side of the plate
4. Apply a drop of threadlocker to the threaded edge of the four VTBTXM8X20A2 screws
5. Insert the four VTBTXM8X20A2 screws into the lowest through-holes of the welded plate from the outer side of the plate.
6. Position the toothed shaft against the outer side of the welded plate so that the red lines are at the top and the yellow lines at the bottom.
7. Screw securely in place with a Torx T40 wrench.

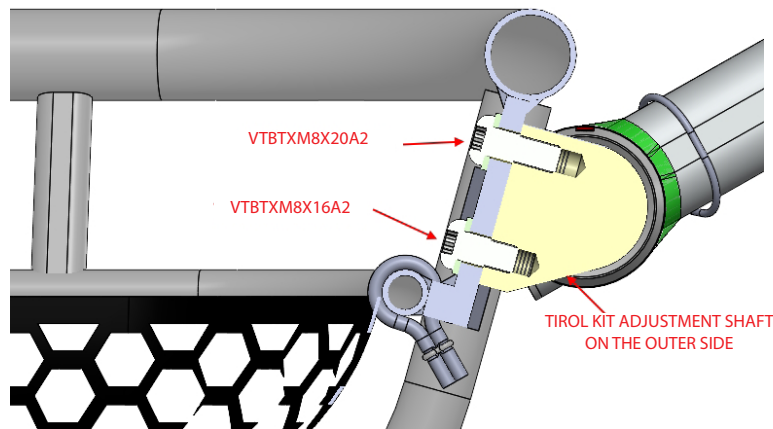



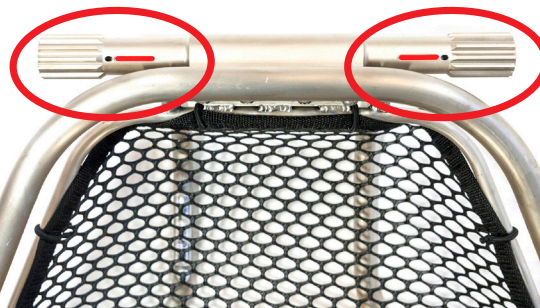

WARNING

When mounting the toothed shafts in the outer position, ensure that they have the red lines facing upwards.





4.1.2. Toothed shaft assembly on stretchers with Adapter Kit

REQUIRED MATERIAL

Images	Part no.	Description
 x 16	UNI 9327A4M8X35	Allen screw with hexagon socket head (supplied with Adapter Kit)
 x 2	10-3001-4NP	Toothed shaft
 x 1	10-00382	Threadlocker
 x 1	00310758	5 mm Allen wrench

 **IMPORTANT**

If you opt to install the Tirol Kit on stretchers that feature the Adapter Kit, the following material will remain unused, as the screws in the Adapter Kit will be used:

Images	Part no.	Description
 x 8	VTBTXM8X16A2	M8 screw with 16 mm Torx countersunk head
 x 8	VTBTXM8X20A2	M8 screw with 20 mm Torx countersunk head
 x 16	RPIM8X16A2	M8x16 flat washer

Instructions

To perform the correct procedure, proceed as described below:

1. Position the toothed shaft of the Tirolo Kit on the outer side of the Adapter Kit so that the red lines are at the top and the yellow lines are at the bottom.
2. Apply 1 drop of threadlocker to each of the 8 hexagon socket head Allen screws UNI 9327A4M8X35 required to mount the toothed shaft.
3. Insert the eight hexagon socket head Allen screws UNI 9327A4M8X35 into the holes of the Tirolo Kit Adapter from the inside and screw in with the 5 mm Allen wrench.

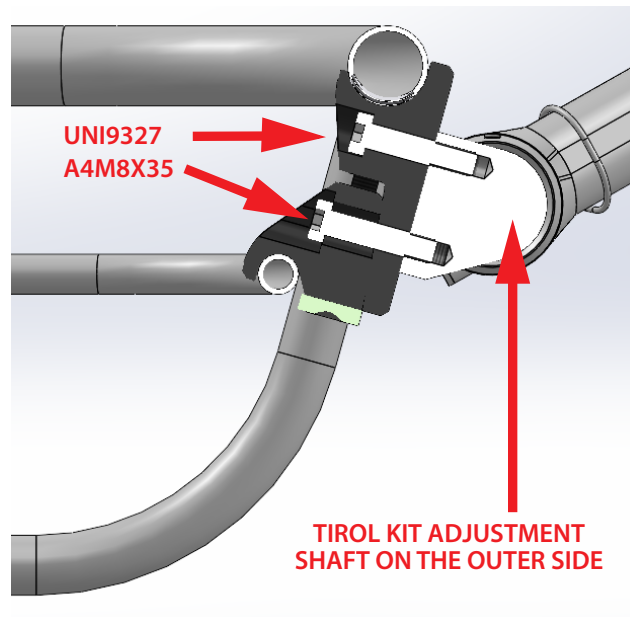

WARNING

On stretchers that feature the Adapter Kit, the toothed shafts can only be mounted in the outer position.

When mounting the toothed shafts in the outer position, ensure that they have the red lines facing upwards.

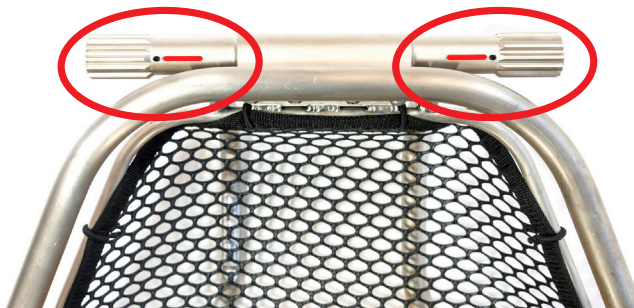

4.2 Handle assembly

When fitting the handles, ensure that the toothed shafts have already been installed.

To perform the correct procedure, proceed as described below:

1. Pull the pin outwards, pressing the red button.

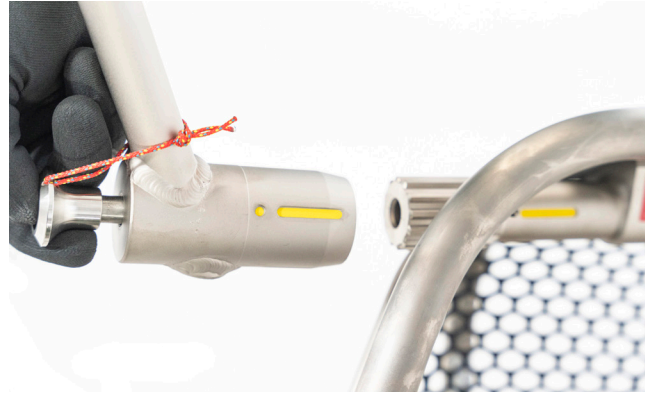

2. Insert the handle hub on the shaft in the desired position and secure the pin by pushing it inside, pressing the red button.
3. Repeat the procedure for all handles.



WARNING

The device has been developed and tested for use with all the components indicated in this manual.

Do not use the Tirol Kit without handles or other components that are essential for the correct use of the device.

4.2.1 Adjusting the angle of the handles

Each handle can be adjusted to twelve different positions to meet the needs of any operator and situation.

To adjust the tilt of a handle, pull it out by releasing the pin as explained above.

Choose the desired angle and reinsert the handle, locking it properly in place.

IMPORTANT

YELLOW MARKING ON HANDLES

There are two yellow marks on the hub of the handles:

1. A yellow line
2. A yellow line with a dot

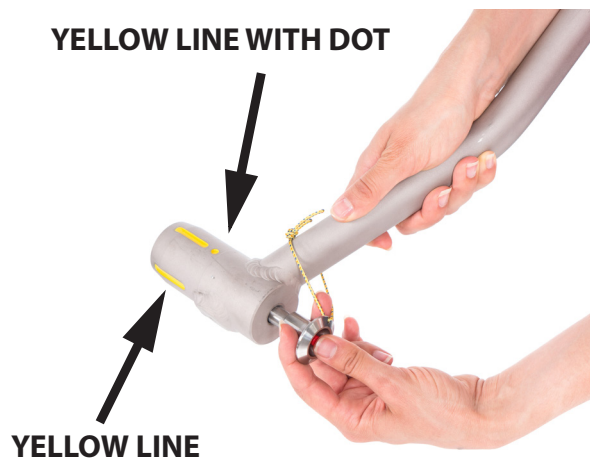

These marks are intended to indicate the following suggested positions:

- **TRANSPORT POSITION**
- **CPR / STATIONARY POSITION FOR PATIENT MANAGEMENT**

! IMPORTANT

Transport Position

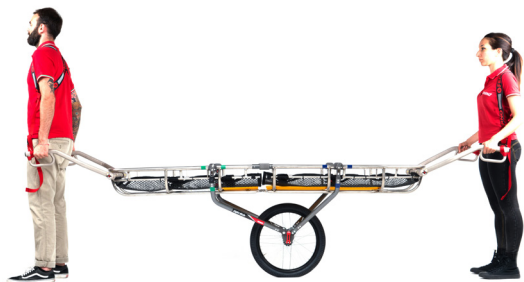

The handles can be set to the transport position (the position most commonly chosen by operators during transportation).

This position is achieved by installing the handles so that the **yellow line with the dot** is aligned with the upper mark of the toothed shaft (yellow line if the shaft is mounted on the inside or red line if it is mounted on the outside of the stretcher).



! IMPORTANT

CPR / stationary position for patient management

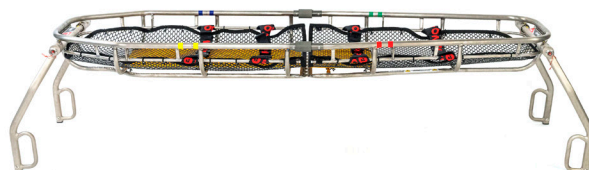

The handles can be set to the stationary position to turn the stretcher into a working and handling platform.

This position is achieved by installing the handles so that the **yellow line (without the dot)** is aligned with the upper mark of the toothed shaft (yellow line if the shaft is mounted on the inside or red line if it is mounted on the outside of the stretcher).

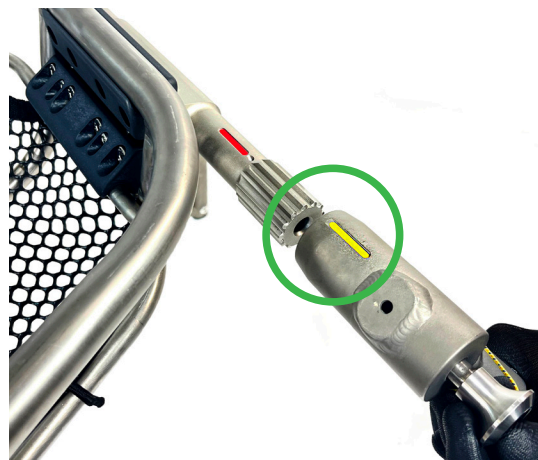

4.3 V-Shaped support assembly

FITTING THE V-SHAPED WHEEL SUPPORT

To perform the correct procedure, proceed as described below:

1. After mounting the toothed shafts, place the stretcher on the ground.
2. Take the two V-Shaped wheel supports and, following the colour-coded labels, attach them to the upper tube of the stretcher at the coloured stripes.
3. To fasten the V-Shaped supports, press the quick-release system against the upper frame of the stretcher until you hear the click of the locking system activation.

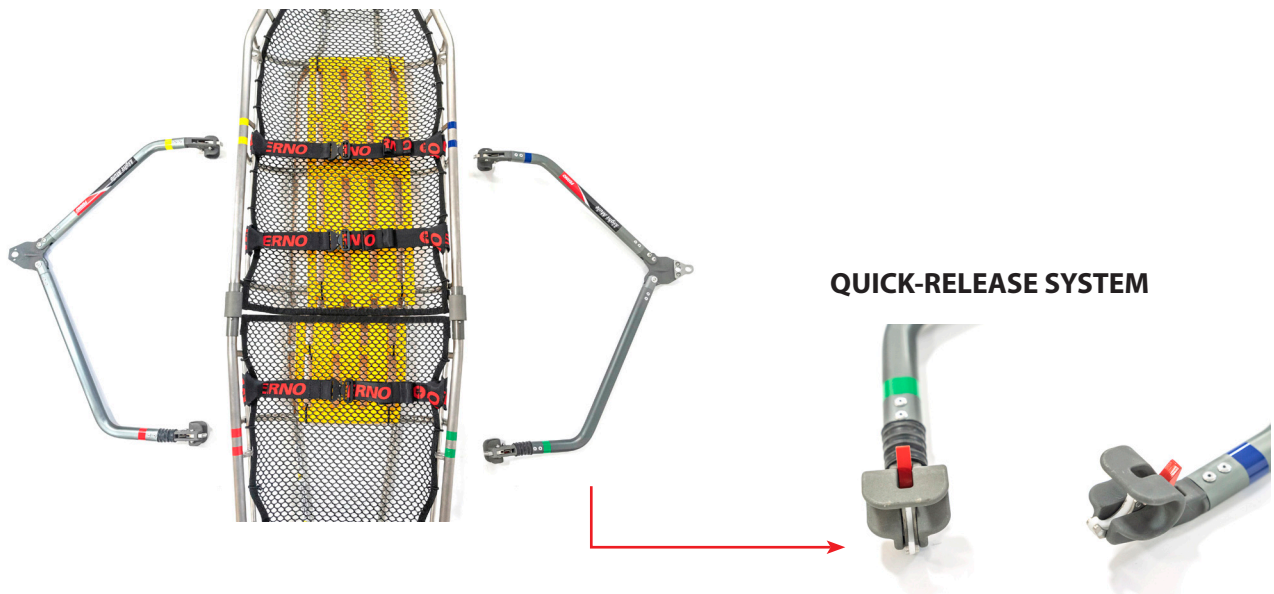

4. Check that the V-Shaped wheel supports are correctly engaged and can rotate smoothly around the tube.
5. Repeat this procedure on both sides of the stretcher.

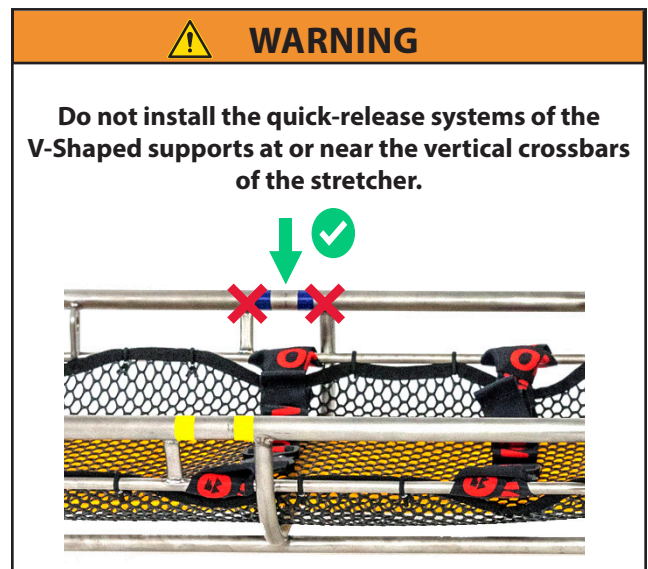
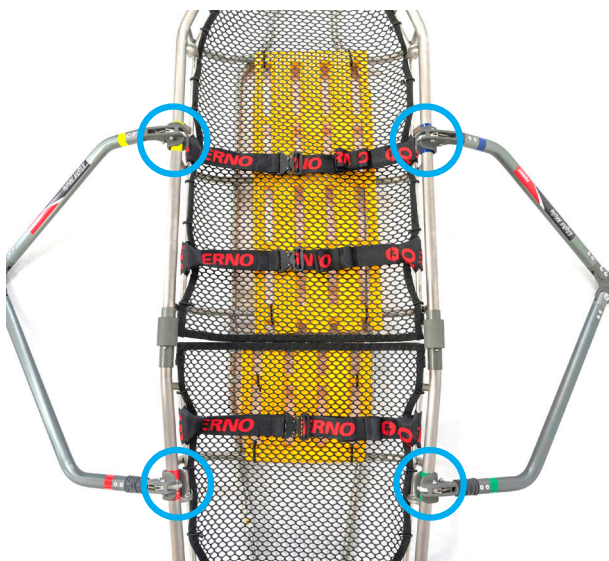

4.4 Wheel assembly

4.4.1 Wheel assembly for Tirol Kit and Xtreme Tirol Kit



WARNING

If the patient is already on the stretcher, the wheel assembly procedure must be carried out in accordance with local protocols.



WARNING

During installation, the wheel must always remain raised off the ground to allow for proper alignment of the pin.

FITTING THE WHEEL

To perform the correct procedure, proceed as described below:

1. Lift the stretcher with or without the aid of the carrying handles.
2. Rotate the V-Shaped supports so that they are positioned under the stretcher.
3. Place the wheel between the supports and insert the locking pin from the side opposite the threaded hole, making sure that it can turn.



4. Screw the pin in firmly and close the red locking lever.



IMPORTANT

If it is not possible to close the lever completely, slightly loosen the wheel locking pin until it can be properly secured.

WHEEL INFLATION ADAPTER

If it is necessary to inflate the wheel using the pump included in the Tire Kit (optional Tirol Kit accessory) or another similar inflation system, the (Presta to Schrader) adapter supplied can be used.



The adapter is connected to a ring similar to a key ring. To use it, the end connected to it must be unscrewed. To inflate the wheel, unscrew the valve cap and screw the adapter onto it before using the chosen inflation pump.

To remove the adapter, unscrew it from the valve, screw the cap back on and screw the ring back onto the adapter.

REMOVING THE WHEEL

To perform the correct procedure, proceed as described below:

1. Remove the pin.
2. Remove the wheel.



3. Disengage the V-Shaped wheel supports by pressing the red button at the quick-release system.



4.4.2 Wheel assembly for Xtreme Control Tirol

⚠ WARNING
 During installation, the wheel must always remain raised off the ground to allow for proper alignment of the pin.

⚠ WARNING
 If the patient is already on the stretcher, the wheel assembly procedure must be carried out in accordance with local protocols.



FITTING THE WHEEL

To perform the correct procedure, proceed as described below:

1. Lift the stretcher with or without the aid of the carrying handles.
2. Rotate the V-Shaped supports so that they are positioned under the stretcher.
3. Place the wheel between the V-Shaped supports, making sure to insert the anti-rotation pin on the wheel in the lower hole of the support.



4. Insert the locking pin from the right side of the patient, making sure that it can turn.
5. Tighten the pin firmly to connect the two V-shaped supports and close the red locking lever.

! IMPORTANT
 If it is not possible to close the lever completely, slightly loosen the wheel locking pin until it can be properly secured.

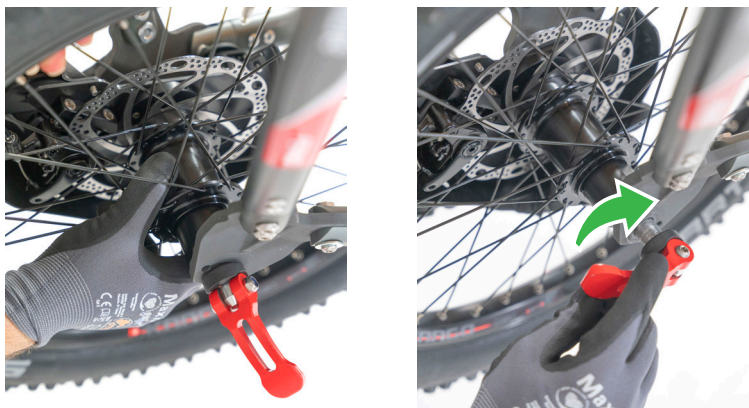

6. Install the brake lever on one of the handles on the patient's left side, using the relevant clamp. The operator can choose installation on the head or foot end.



NOTE: it is possible to decide whether to mount the brake lever inside or outside the handle. Depending on the chosen position, the brake lever can be adjusted using the special positioning knob by loosening it, moving the brake lever to the chosen side and screwing it back in to secure it.

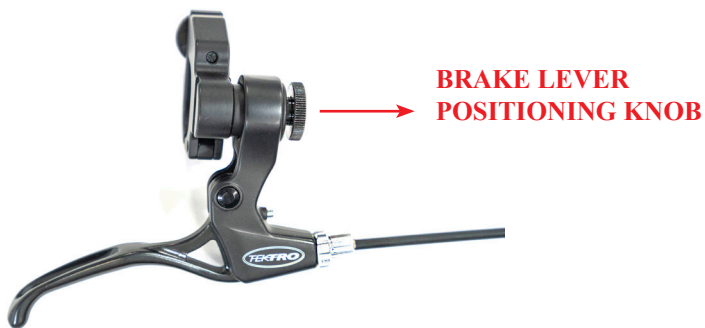

! IMPORTANT

To install the brake lever on the handle, the assembly can be placed in one of the following positions, depending on the convenience and needs of the operator:

1. Internal clamp in front of the handle
2. Internal clamp at the handle
3. External clamp in front of the handle
4. External clamp at the handle

In any case, if the clamp is positioned in front of the handle, it must be installed close to the vertical metal tube, as shown in the figure.



7. Secure the cable to the lower frame of the stretcher using the clips.



WARNING

If, after mounting the wheel, you are unable to brake correctly when pulling the lever, you may need to perform one of the following actions:

- Cleaning the wheel (See section Cleaning the Xtreme Control wheel)
- Adjusting the brake pads on Xtreme Control wheel (See section Brake pad adjustment on Xtreme Control wheel)

SAFETY LIGHT

The safety light consists of two parts:

- An adjustable elastic strap.
- An unscrewable LED which can be recharged via micro USB port.

The safety light can be mounted:

1. On the suitable support located at the brake casing
2. On the main tubes of the stretcher.
3. On the handles or V-Shaped supports of the Tirol Kit

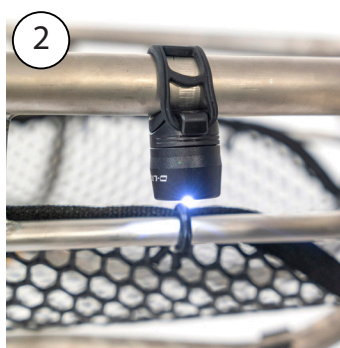

Once secured in the desired position by means of the elastic strap, it can be switched on by simply pressing twice on the LED. Depending on how many times it is pressed, you will have, in the following order:

- Flashing light
- Steady light
- Pulsed light
- Light off

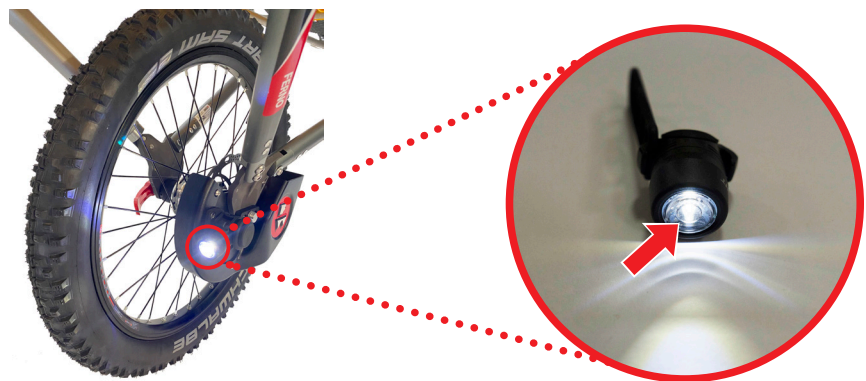

When the light battery runs out, it can be easily recharged by unscrewing the upper part containing the LED and connecting the supplied cable to the micro USB port.



WHEEL INFLATION ADAPTER

Should it be necessary to inflate the Xtreme Control wheel using the pump supplied with the Tire Kit or another similar inflation system, there is an adapter (Presta to Schrader valve) inside the light support.



To remove the adapter, remove the round rubber cap from the light support and unscrew the adapter inside it.

To attach the adapter, unscrew the valve cap and screw the adapter firmly onto it, before using the chosen inflation pump.

To remove the adapter, unscrew it from the valve, screw the cap back on and replace the adapter inside the light support by engaging the screw inside.

Close the light support with the suitable cap.

REMOVING THE WHEEL

To perform the correct procedure, proceed as described below:

1. Remove the pin.
2. Remove the wheel.



3. Disengage the V-Shaped wheel supports by pressing the red button at the quick-release system.



4. Release the cable from the frame by releasing the clips.
5. Remove the brake lever from the handle.

4.5 Shoulder support application

After fitting the handles, a set of straps can be put on for load handling.

The Shoulder Supports consist of a harness that has a detachable loop at each end via a “Cobra” buckle.

To attach the Shoulder Supports to the handles, proceed as described below:

1. Wear the harness as a backpack.



2. Release the “Cobra” buckle on one of the 2 sides.
3. Insert the loop of the short end just released into the corresponding handle and secure it to it by means of a “wolf’s mouth” knot so that it remains positioned in the outermost upper corner of the handle with one loop attached to the horizontal tube and the other to the vertical tube.



4. Reconnect the 2 ends by re-attaching the “Cobra” buckle and adjust the length of the harness by pulling or loosening the end of the strap.



5. MAINTENANCE

5.1 Periodic maintenance and preventive checks



IMPORTANT

The use of products containing chlorine, phenols and iodine may damage the product. Do not use products containing these agents for cleaning/disinfection.

PERIODIC Maintenance:

If there are signs of wear and damage, discontinue use of the stretcher and immediately contact Ferno S.r.l. Technical Support Service.

Ferno S.r.l. directly carries out repair/maintenance operations, without the need of dealers, mechanics or external service centres. You are thus invited to be wary of those who present themselves as Ferno S.r.l. authorised technician.

PREVENTIVE Checks:

It is the user's responsibility to carry out preventive maintenance work as set out in the table below and in the "Check-list for inspection of devices" at the end of this chapter.

Preventive check intervals	After each use	Whenever necessary	Every month
Disinfection	•	•	
Cleaning		•	•
Inspection	•	•	•
Lubrication		•	

If the device undergoes particularly heavy use, checks should preferably be carried out on a more frequent basis.



IMPORTANT

If the devices are not used, store them indoors in a dry place out of direct sunlight.



IMPORTANT

Before disinfection/cleaning, make sure the restraints are removed.

After disinfection/cleaning, ensure that the stretcher and its components are completely dry before use.

CHECK-LIST FOR INSPECTION OF DEVICES

- Are all the components present?
- Does the device show signs of wear or oxidation?
- Are all screws, bolts, and pins in place and securely mounted?
- Do all the moving parts work properly?
- Do all the closing devices work properly?
- Are all labels present and clearly legible?
- Do the handles work properly?
- Do the handles show cracks, dents or signs of wear and/or deformation?
- Do the V-Shaped wheel supports show cracks, dents or signs of wear and/or deformation?
- Is the wheel in good condition and without cracks, dents or signs of wear and/or deformation?
- Does the wheel tyre have tears, holes or signs of wear?
- Does the tyre inner tube stay inflated or does it tend to deflate abnormally?
- Are shoulder supports in good conditions, without tears or frayed edges?
- Are the buckles on the shoulder supports intact and functioning properly?
- Do the Tirol Kit and any additional accessories function correctly without interfering with the use of the stretcher?

FOR THE XTREME CONTROL TIROL KIT VERSION

- Does the braking system work properly?
- Does the brake lever clamp stay firmly in place when installed?
- Are the locking clips of the brake cable intact and do they stay properly attached to the stretcher frame when applied?
- Does the protective casing of the disc brake show cracks or breaks?
- Is the light working and charging correctly?

5.2 Disinfection/Decontamination

To carry out proper disinfection/decontamination, proceed as described below:

1. After each use, clean the surfaces of the device with a non-abrasive surface disinfectant.
2. Do not immerse the device directly in disinfectant.
3. During disinfection, ensure there are no signs of wear and/or damage.
4. Dry with a cloth. Ensure all the components of the device are completely dry before reusing them.

It is advisable to wear suitable gloves (e.g. household or disposable gloves) during disinfection.

5.3 Disinfection/Cleaning of Shoulders Supports

To carry out proper disinfection/cleaning of the Shoulders Supports, proceed as described below:

1. Remove the Shoulder Supports from the device.
2. Re-fasten the “Cobra” buckles.
3. Place the Shoulder Supports in a fabric bag (not supplied) and then in an industrial washing machine.
4. Wash at low temperature with detergent and use a gentle cycle. Do not use bleach or other aggressive products.
5. Remove the Shoulder Supports from the bag and allow them to dry thoroughly. Do not put in dryer.

5.4 Cleaning the “slim” and Xtreme wheels

After using the device on muddy or very dirty ground, it is advisable to clean the wheel thoroughly.

To perform the correct procedure, proceed as described below:

1. Initially remove as much dirt and dust as possible using compressed air from a distance to avoid damaging the product.
2. Clean the wheel and locking pin with water and dry them with a cloth.
3. After cleaning the surfaces, if necessary, lubricate the hub using marine grease or water-resistant grease.

5.4.1 Cleaning the Xtreme Control wheel

After using the device on muddy or very dirty ground, it is advisable to clean the wheel thoroughly.

To perform the correct procedure, proceed as described below:

1. Initially remove as much dirt and dust as possible using compressed air from a distance to avoid damaging the product.
2. Clean the wheel and locking pin with water and dry them with a cloth.
3. If the braking system is still dirty, remove the casing (see section *Brake pad adjustment on Xtreme Control wheel*), clean with water and dry with a cloth.
4. After cleaning the surfaces, if necessary, lubricate the hub using marine grease or water-resistant grease.



WARNING

Do not apply grease used for lubrication to the brake disc.

5.5 Inspection

To ensure optimal use of the devices, it is important to keep all the components in good conditions and to remove all traces of dirt, debris and body fluids. The devices must be inspected before and after use and must be cleaned after each use.

When not in use, the devices must be stored in a dry, indoor environment and inspected at least once a month.

The device should be inspected regularly by maintenance personnel. Perform the various checks indicated in this manual.

If signs of wear or damage are found during the inspection, stop using the device immediately and contact the Ferno S.r.l. Technical Support Service to request repairs/maintenance (see chapter on technical support).

5.6 Lubrication

Disinfect and clean the device before applying the lubricant.

There are two lubrication areas in the Tirol Kit:

- On the quick-release mechanism of the V-Shaped wheel forks.
- In the holes housing the wheel locking pin.

To perform the correct procedure, proceed as described below:

1. Lubricate with one drop of oil SAE 30
2. Move the mechanism back and forth several times to get the oil into the guide.
3. Remove any excess lubricant with a cloth.



WARNING

Do not lubricate parts unnecessarily as this can cause dirt and particles to deposit on lubricated parts and cause damage. Lubricate only the points indicated.



WARNING

Improper maintenance may cause serious accidents, injuries and/or damage.

Perform maintenance as described in this user manual.

5.7 Brake pad adjustment on Xtreme Control wheel

If the pads are worn, they must be replaced.

To perform the correct procedure, proceed as described below:

1. Remove the casing and light support with a 3 mm Allen wrench (not supplied) by unscrewing the six screws.
2. Adjust the brake calliper using a 4 mm Allen wrench (not supplied), working from both sides of the calliper.
3. Once the operation has been carried out, reposition the casing and light support by re-tightening the six screws.



6. ACCESSORIES



Picture	Part Number (item/ PN)	Description	Compatibility
	EARS	Anti-rotation sail (Ears)	Compatible with all Titan basket stretchers
	21-0120-019	Winter Kit for Tirol Kit	Compatible with all TAPERED Titan basket stretchers
	TYRE KIT	Inner tube + Pump + Repair kit	Compatible with the Tirol Kit in all three versions.
	15-0106	SOFT Eye suspensions	Compatible with all Titan basket stretchers
	15-0105	HARD Eye suspensions	Compatible with all Titan basket stretchers
	10-2916-001	Titan-Ti and Tirol Kit backpack harness	Compatible with all Tirol Kits and DIVISIBLE TAPERED Titan basket stretchers
	TIROL KIT BAG PLUS	Tirol Kit Bag Plus	Compatible with all Tirol Kits and DIVISIBLE Titan basket stretchers

Picture	Part Number (item/ PN)	Description	Compatibility
	21-0120-010	Titan protection in Polyethylene	Compatible with TAPERED Titan basket stretchers
	21-0120-010_1	Titan protection in Polyethylene	Compatible with DIVISIBLE TAPERED Titan basket stretchers
	11-0124Aw	Toboga Flotation Collar	Compatible with all Titan basket stretchers
	0822097	Patient Shield	Compatible with all Titan basket stretchers without welded plates and without Adapter Kit
	25-00082	Tirol Kit ADAPTER for TAPERED Titan Basket Stretchers	See chapter 7.1 Adapter Kit.
	25-00099	Tirol Kit ADAPTER for REGULAR Titan Basket Stretchers	See chapter 7.1 Adapter Kit.
	25-00158	Xtreme wheel	Compatible with all Tirol Kit models
	25-00132	Xtreme Control wheel	Contact Ferno to check compatibility

6.1 Adapter Kit

The Adapter Kits make the Tirol Kit in its three versions compatible with Titan stretchers without welded plates.

6.1.1 Compatible stretchers

<p style="text-align: center;">ADAPTER KIT FOR TAPERED STRETCHERS</p> <p style="text-align: center;">PN: 25-00082</p> 	<p style="text-align: center;">ADAPTER KIT FOR REGULAR STRETCHERS</p> <p style="text-align: center;">PN: 25-00099</p> 
<p>Compatible stretchers:</p> <ul style="list-style-type: none"> - part no. 11-0100A - part no. 11-0119SL - part no. 11-0118SL 	<p>Compatible stretchers:</p> <ul style="list-style-type: none"> - part no. 11-0101A - part no. 11-0115SL - part no. 11-0116SL

6.1.2 Installing the Adapter Kit for tapered stretchers

Required material

- 1 - no.1 4 mm Allen wrench
- 2 - no.1 6 mm Allen wrench
- 3 - no.1 Threadlocker

Head end

- 4 - no.1 Upper plate "A"
- 5 - no.1 Lower plate "A"
- 6 - no.1 Counter-plate "A"
- 7 - no.2 1mm shim for Tirol Kit Adapter plates
- 8 - no.2 Hexagon socket head cap screw UNI 5931 A4/80 M5x25.
- 9 - no.2 Hexagon socket head cap screw UNI 59531 A4/80 M8x50.
- 10 - no.4 Countersunk hexagon head socket cap screw ISO 10642 A4/70 M6x16.

Foot end

- 11 - no.1 Upper plate "B"
- 12 - no.1 Lower plate "B"
- 13 - no.1 Counter-plate "B"
- 14 - no.2 1mm shim for Tirol Kit Adapter plates
- 15 - no.2 Hexagon socket head cap screw UNI 5931 A4/80 M5x25.
- 16 - no.2 Hexagon socket head cap screw UNI 59531 A4/80 M8x50.
- 17 - no.4 Countersunk hexagon head socket cap screw ISO 10642 A4/70 M6x16.

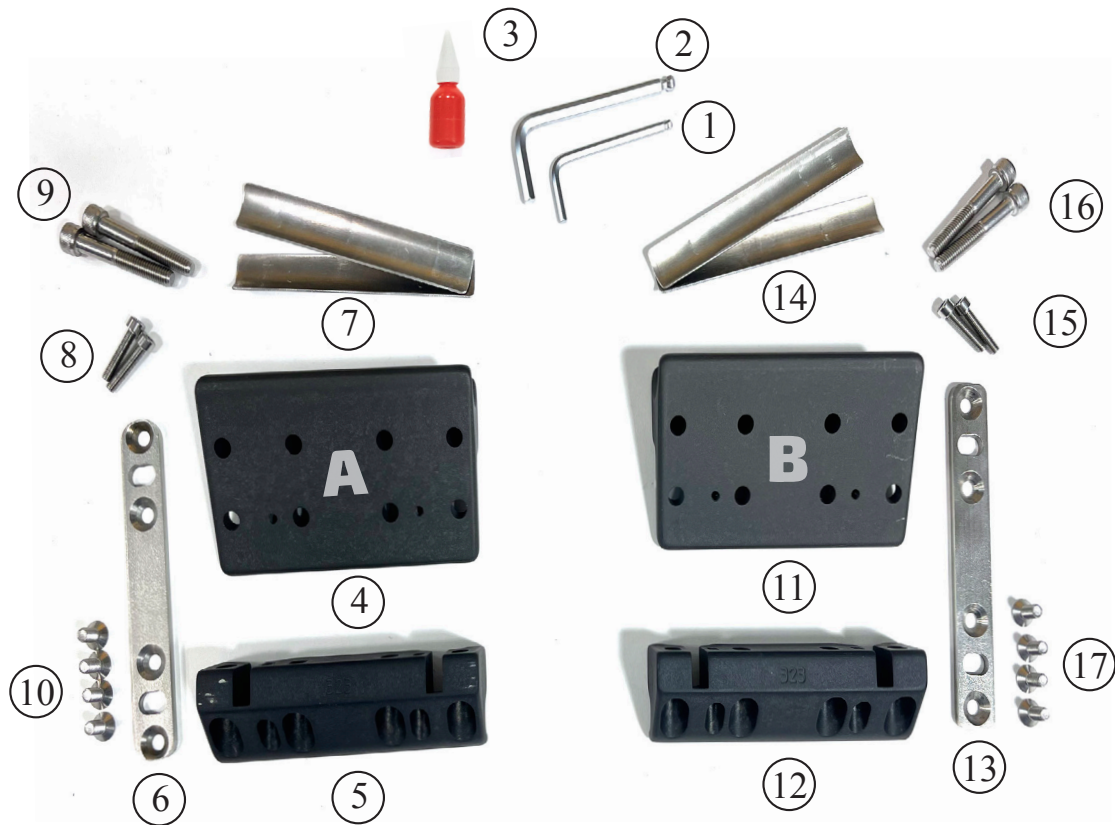

Instructions

To perform the correct procedure, proceed as described below:

1. Join the two upper and lower plates "A".



2. Apply a drop of threadlocker to the threaded end of the two M5x25 hexagon socket head screws.

3. Screw them lightly into the circled holes using the 4 mm Allen wrench so that the two adapter plates of the Tirol Kit are connected but there may still be some play between them.

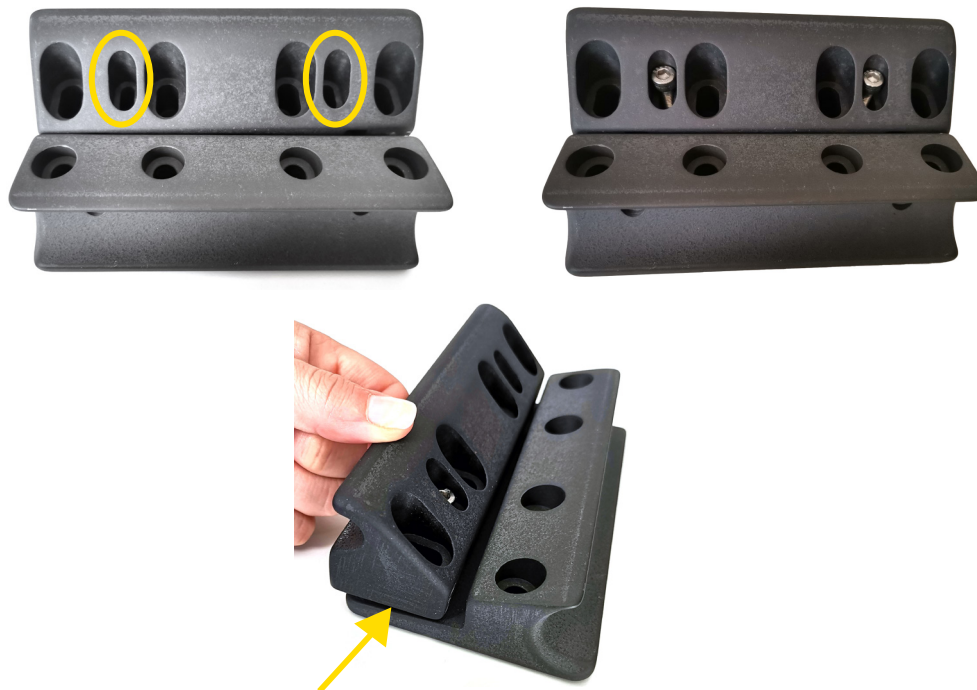

4. Place the connected plates in a vertical position.
5. Apply 1 drop of threadlocker to the threaded end of the two M8x50 adjustment screws.

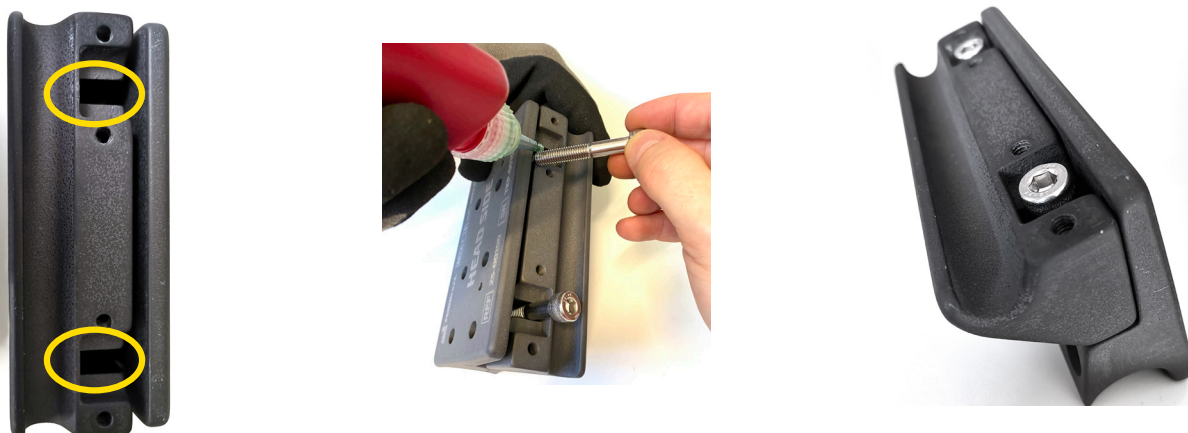

6. Tighten them in the circled holes using the 6 mm Allen wrench until there is no more play between them.

- Place the counter-plate on the lower plate so that the adjustment screws can be seen, taking care that the recessed hole remains on the outside.



- Apply a drop of threadlocker to the threaded end of the four M6x16 countersunk head screws.
- Using the 6 mm Allen wrench, lightly tighten the counter-plate on the lower plate by screwing in the four M6x16 countersunk screws.

NOTES: Maintain a gap of a few millimetres between the counter-plate and the lower plates.



- Loosen the adjustment screws with the 6 mm Allen wrench so that the adapter plates of the Tirol kit are connected but play between them is still possible.



11. Insert the assembly between the tubes at the end of the Titan stretcher by first fitting the assembly to the lowest tube and then fitting it to the highest tube.



12. Turn the stretcher with the bottom upwards.
13. Tighten the two M8x50 hexagon socket head screws.
14. Tighten the four M6x16 countersunk screws until the counter-plate is firmly attached to the lower plate of the Tirol Kit Adapter.
15. Loosen the adjustment screws with the 6 mm Allen wrench so that the plates of the Tirol Kit Adapter move away and adhere to the stretcher tubes.
16. Turn the stretcher in the direction of use.
17. Tighten the two M5x25 hexagon head screws securely.
18. Repeat the procedure on the foot end using plate "B".

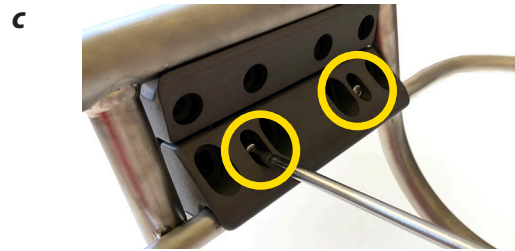
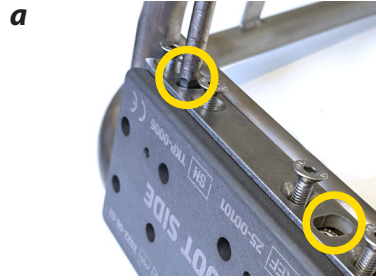

! IMPORTANT

If the Tirol Kit Adapter does not fit tightly onto the stretcher tubes even after the adjustment screws have been fully loosened, loosen the entire assembly slightly in order to return to step 5.

Before proceeding with steps 6-12, insert a shim (or two if necessary), between the plate assembly and the highest tube of the stretcher, before screwing the assembly back together.

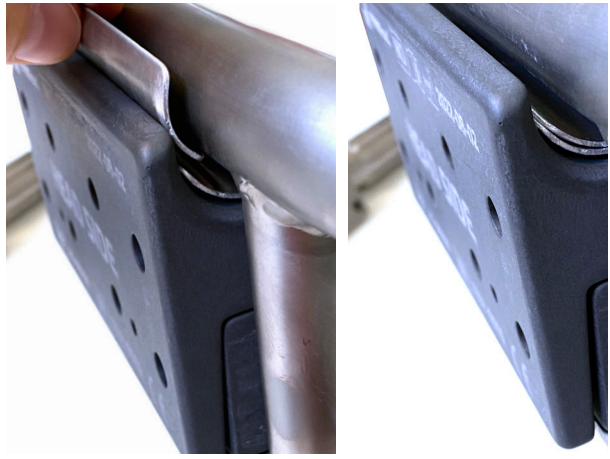

6.1.3 Installing the Adapter Kit for regular stretchers

Required material

- 1 - no.1 x 4 mm Allen wrench
- 2 - no.1 x 6 mm Allen wrench
- 3 - no.1 x Threadlocker

Head end

- 4 - no.1 Upper plate "A"
- 5 - no.1 Lower plate "A"
- 6 - no.1 Counter-plate "A"
- 7 - no.2 1mm shim for Tirol Kit Adapter plates
- 8 - no.2 Hexagon socket head cap screw UNI 5931 A4/80 M5x25.
- 9 - no.2 Hexagon socket head cap adjustment screw UNI 59531 A4/80 M8x50.
- 10 - no.4 Countersunk hexagon head socket cap screw ISO 10642 A4/70 M6x16.

Foot end

- 11 - no.1 Upper plate "A"
- 12 - no.1 Lower plate "A"
- 13 - no.1 Counter-plate "A"
- 14 - no.2 1mm shim for Tirol Kit Adapter plates
- 15 - no.2 Hexagon socket head cap screw UNI 5931 A4/80 M5x25.
- 16 - no.2 Hexagon socket head cap adjustment screw UNI 59531 A4/80 M8x50.
- 17 - no.4 Countersunk hexagon head socket cap screw ISO 10642 A4/70 M6x16.

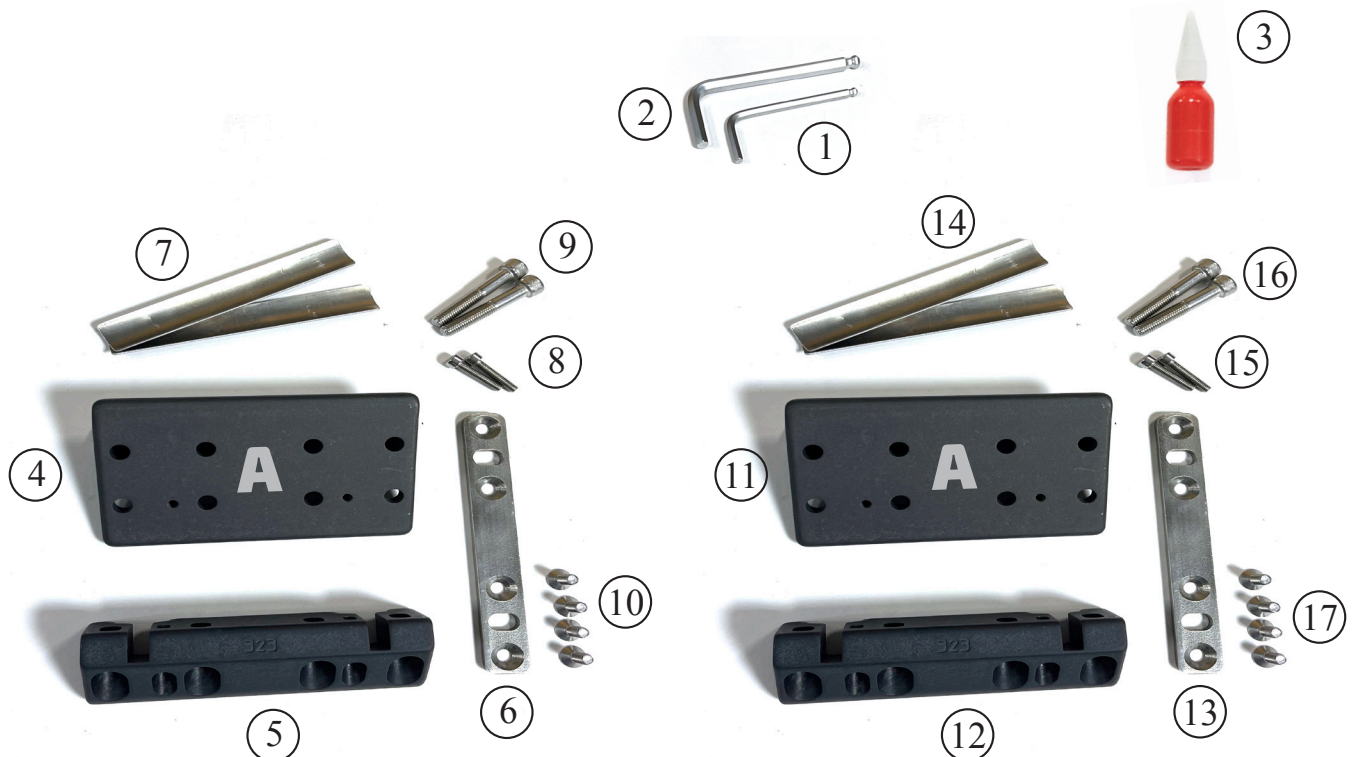

Instructions

Follow the same instructions as for the TAPERED basket stretcher, applying 2 plates “A” instead of 1 plate “A” and 1 plate “B”.

7. TECHNICAL SUPPORT

Technical Support Service

For technical support concerning products, contact the Ferno S.r.l. Technical Support Service.

- Telephone: 800 501 711 (toll-free for Italy)
- Telephone: (+39) 0516860028
- Fax: (+39) 0516861508
- Website: www.ferno.it

For more information on the Ferno S.r.l. device, and to schedule training courses on its correct use, contact the Ferno S.r.l. Customer Service team.

- Telephone: 800 501 711 (toll-free for Italy)
- Telephone: (+39) 0516860028
- Fax: (+39) 0516861508
- E-mail: info.it@ferno.com
- Website: www.ferno.it



WARNING

Non-original spare parts and inadequate repairs may cause damage and/or injury. Only use Ferno S.r.l. original spare parts and only contact Ferno S.r.l. Customer Service



WARNING

Unauthorised modifications of the stretcher could cause serious damage, injury and/or unforeseeable operating problems. Do not modify or alter the stretcher in any way.

8. WARRANTY

8.1 Warranty Terms and Conditions

Ferno S.r.l. products are guaranteed against manufacturing defects for a period of 24 months from the date on the Ferno S.r.l. shipping document.

Ferno S.r.l. guarantees its spare parts for a period of 12 months.

During the warranty period, Ferno will repair and/or replace any parts found to have manufacturing defects free of charge, excluding the costs of labour, travel, transport, and packaging.

The warranty does not cover consumables or parts subject to wear and tear due to normal use of the product, all parts typically subjected to sliding or rolling friction (lubricants, shoes, etc.), parts potentially exposed to oxidation or corrosion.

Repairs are performed by trained technical staff at the Ferno S.r.l. site in Via Zallone 26- 40066 Pieve di Cento (BO), Italy or at the Customer's premises if suitable arrangements with Ferno S.r.l. Customer Service have been made.

Technical interventions at the Customer's premises must be agreed in terms of price and timing with the company and include a reimbursement of expenses incurred. For information on the costs of technical support, please contact the relevant department at Ferno S.r.l.

Repairs performed by Ferno S.r.l. are guaranteed for 6 months from the date of repair. This warranty applies only when the product is used according to the instructions in the user manual provided.

Misuse and negligence invalidate this warranty.

The warranty is valid from the day the product is shipped from Ferno S.r.l., and the shipping costs are not covered by this warranty. Ferno S.r.l. is not liable for damage incurred during shipment or due to misuse of the product.

Products sold by Ferno S.r.l., that do not bear the Ferno S.r.l. trademark are covered by the warranty of the original Manufacturer. Ferno S.r.l. does not extend the warranty periods of other Manufacturers; Ferno S.r.l. assumes no responsibility for products manufactured by others.

The warranty is rendered null and void in the case of:

- failure to observe the operating instructions,
- inappropriate use or handling,
- repairs of critical components by non-authorized personnel,
- damage during transport due to improper packaging of items returned by the user,
- failure to perform preventive checks
- failure to use original spare parts.

In cases not covered by the warranty, Ferno S.r.l. will not cover the transport costs for sending or returning the product.

8.2 Limitation of liability

If a product is found to be defective, Ferno S.r.l. will repair and replace it, or, at its own discretion, refund the purchase price.

Under no circumstances can Ferno S.r.l. be held liable for a price higher than the selling price of the product.

The buyer accepts these conditions for all types of damage. Ferno S.r.l. does not offer other warranties, express or implied, including implied warranties of merchantability or fitness for a particular purpose, for its own products or for products manufactured by others.

In case of infringement of the limited warranty, any legal actions must be filed within one year from the date on which the infringement was, or should have been, discovered.

The warranty on purchased products becomes void and Ferno S.r.l. does not guarantee their safety under the following circumstances:

- if the labels or plates bearing the Manufacturer's logo and/or the serial number are rendered illegible or removed;
- if the product has undergone modifications, repairs or other operations not authorised by Ferno S.r.l. and performed by personnel not authorised by Ferno S.r.l., excluding non-critical components correctly installed in accordance with the operating instructions.
- if the product is not used according to instructions, or for purposes other than those for which it was intended.
- if the warranty is denied for the reasons set out in section 9.1.

Ferno S.r.l. cannot, in any event, be held liable for direct or indirect damage due to use that is non-compliant with the instructions in the user manual or the intended purpose of the product.

8.3 Warranty claims

Contact Ferno S.r.l. Customer Service immediately if you receive a product that is suspected to be defective.

An agent will assist the customer through the complaints procedure.

Before returning a product to Ferno S.r.l., contact Ferno S.r.l. Customer Service to request authorisation

8.4 Complaints

Any complaints must be communicated to the reseller or to Ferno S.r.l. Customer Service, within 5 days of receipt of the product or of discovery of the alleged defect.

Claims or disputes regarding a single product shall not release the buyer from the obligation to collect and pay for other products in the order, unless otherwise agreed with the seller.

8.5 Return authorisations

No product will be accepted without the prior approval of Ferno S.r.l.

Products returned for business reasons, or for reasons not relating to nonconformity, will be accepted only after verification of their condition by Ferno S.r.l. qualified personnel.

MAINTENANCE RECORD

Date	Type of Maintenance	Maintenance technician

MAINTENANCE RECORD

Date	Type of Maintenance	Maintenance technician

Product User and Maintenance Manual, required to operate the product safely, maintain its efficiency and reliability, and ensure compliance with the terms of the warranty.

Rel.28102024English

Ferno S.r.l.

Via Benedetto Zallone 26
40066 - Pieve di Cento (BO) - ITALY

Telephone (toll-free)	800 501 711
Telephone	(+39) 0516860028
Fax	(+39) 0516861508
Email	info.it@ferno.com
Website	www.ferno.it

Ferno s.r.l., Pieve di Cento, Subsidiary of Savosa

Via Tesserete, 67
6942 - Savosa - SWITZERLAND

Telephone	+41 (0) 412596000
E-mail	info.ch@ferno.com
Website	www.ferno.-schweiz.ch